

# CONTESSA

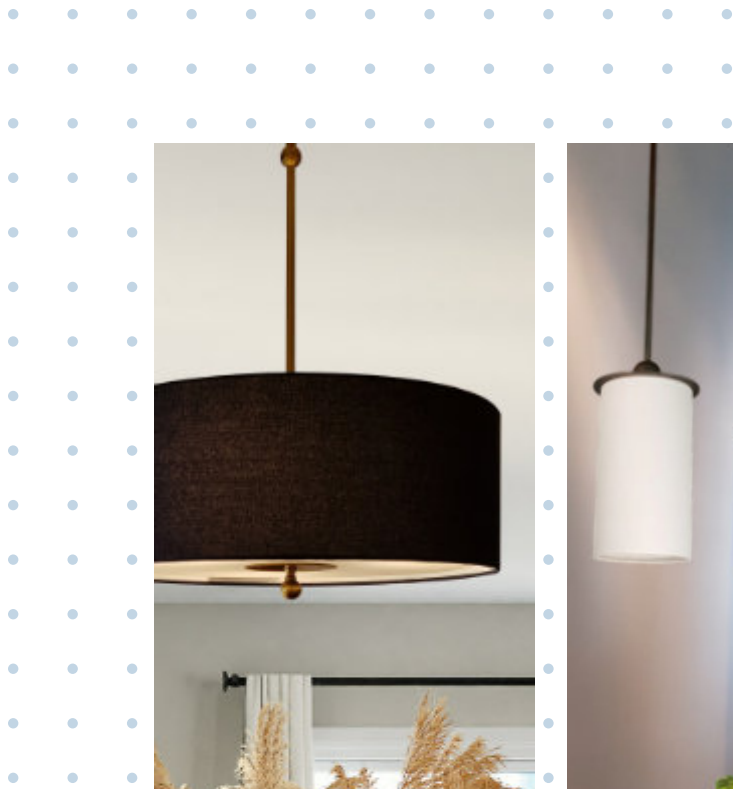

## Classic Pendants

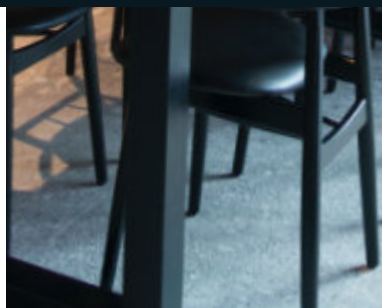
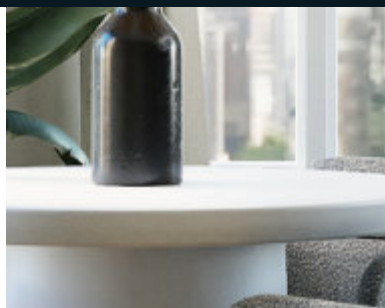

# Classic Drum



CONTESSA  
bespoke lighting design

# Classic Drum



### Physical Characteristics:

Dimensions:  
600mm DIA x 350mm H (+ suspension)

**Shade size can be adjusted to suit client requirements**

#### Mounting:

- Chain suspension 1.2m chain, canopy 120x25mm
- Rod suspension <1.2m fixed rod, canopy 120x25mm

Available with or without the shade. Select the shade finish from the Contessa designer fabric sample folder or specify your own.

### Electrical Configuration:

Power:  
3 x E27 lampholder

Control gear:  
240V E27

Dimming options:  
Use dimmable globes

### Finishes:



Brass



Polished Nickel



Dark Bronze

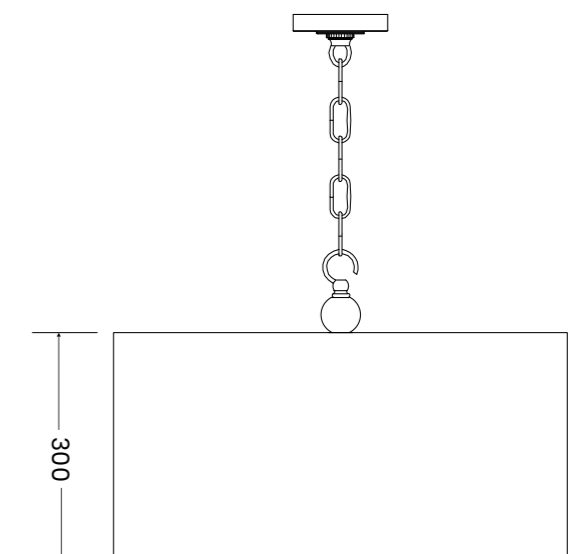
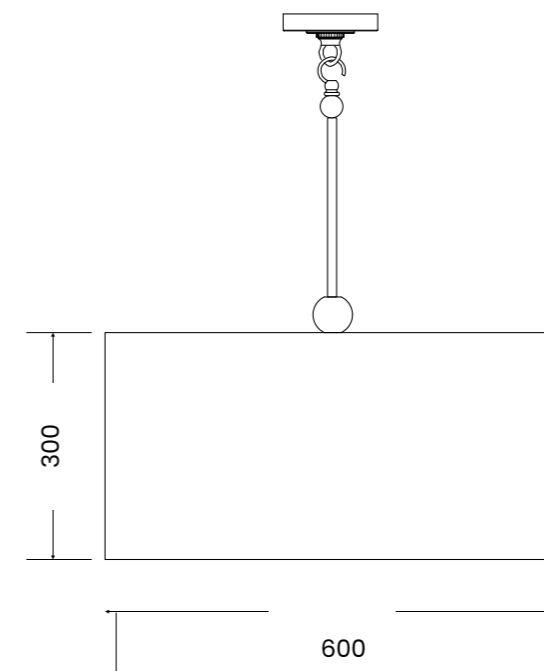

# Classic Conic



CONTESSA  
bespoke lighting design

# Classic Conic



## Physical Characteristics:

Dimensions:  
560x460mm DIA x 350mm H (+ suspension)

**Shade size can be adjusted to suit client requirements**

### Mounting:

- Chain suspension 1.2m chain, canopy 120x25mm
- Rod suspension <1.2m fixed rod, canopy 120x25mm

Available with or without the shade. Select the shade finish from the Contessa designer fabric sample folder or specify your own.

## Electrical Configuration:

Power:  
3 x E27 lampholder

Control gear:  
240V E27

Dimming options:  
Use dimmable globes

## Finishes:



Brass



Polished Nickel



Dark Bronze

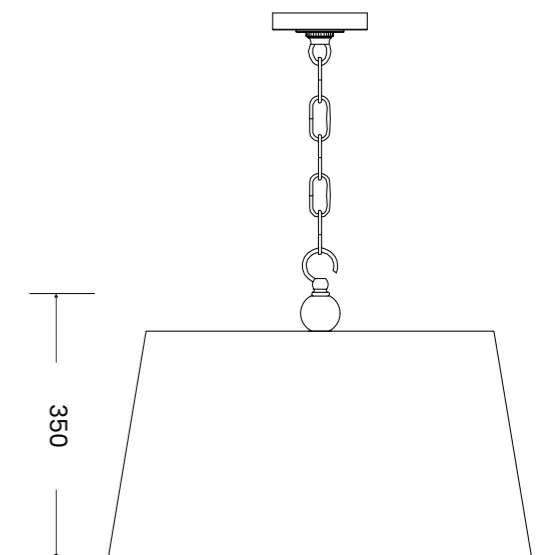
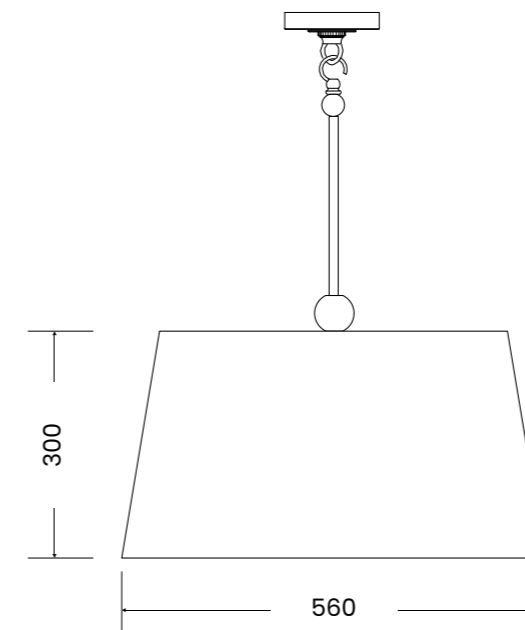

# Classic 1 Light



CONTESSA  
bespoke lighting design

# Classic 1 Light

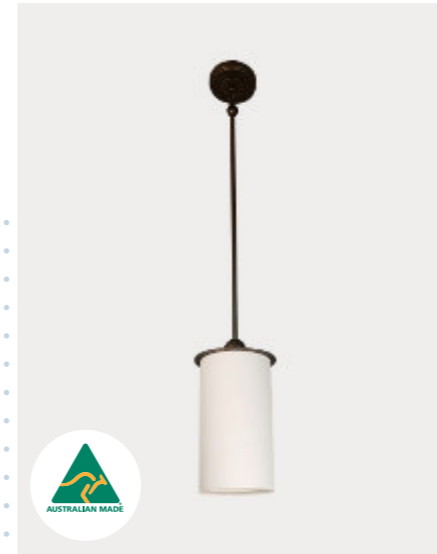

### Physical Characteristics:

**Dimensions:**  
180mm DIA x 330mm H (+ suspension)

#### Mounting:

- Chain suspension 1.2m chain, canopy 120x25mm
- Rod suspension <1.2m fixed rod, canopy 120x25mm

Available with or without the shade. Select the shade finish from the Contessa designer fabric sample folder or specify your own.

### Electrical Configuration:

**Power:**  
1 x E27 lampholder

**Control gear:**  
240V E27

**Dimming options:**  
Use dimmable globes

### Finishes:



Brass



Polished Nickel



Dark Bronze

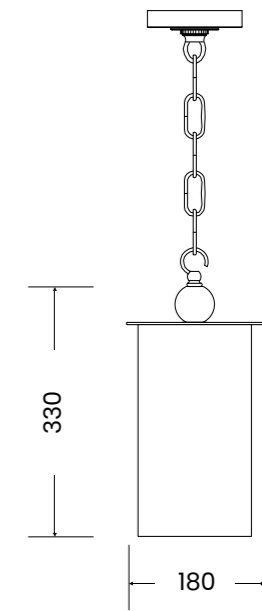
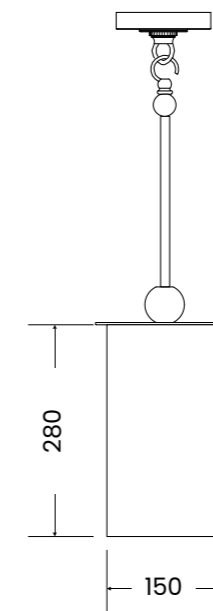

# Bronte

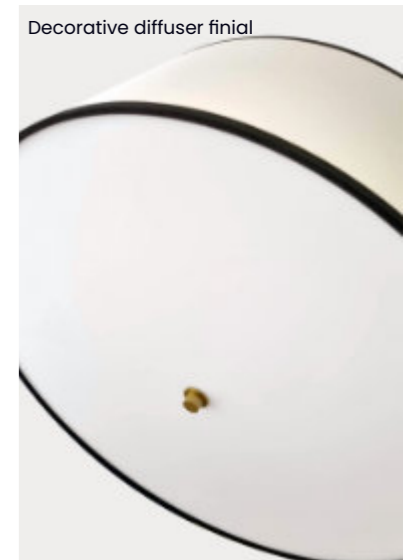
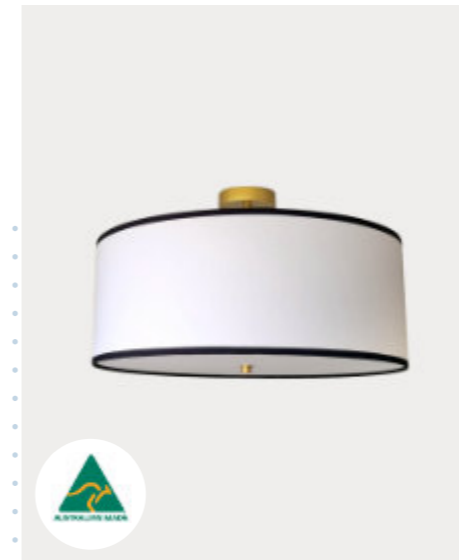

### Physical Characteristics:

**Size options:**  
S - 300mm Dia x 200mm H  
M - 400mm Dia x 200mm H  
L - 450mm Dia x 200mm H\*

**Shade finish:**  
Natural White\*

**Mounting:**  
Rod suspended - Standard 90mm from ceiling to the top of the shade.

### Electrical Configuration:

**Power options:**  
1 x 9W E27 Lamps in S  
3 x 9W E27 Lamps in M & L

**IP Rating:**  
IP20 - For indoor use only. Should not be used in wet areas.

**Control gear:**  
240V (E27 Lamp)

**Dimming options:**  
On/Off  
Phase Cut

### Photometrics:

**Lumen output:**  
850 Lumens per lamp

**LED type:**  
E27 removable LED lamps

**CRI:**  
CRI 80

**CCT:**  
3000K or 4000K

**Distribution:**  
360° direct & in-direct light

### Finishes: (Metal-ware)

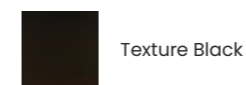

Texture Black

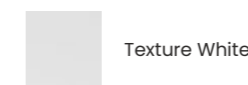

Texture White



Satin Brass\*

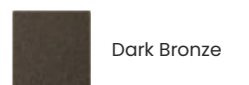

Dark Bronze

### Dimensions:

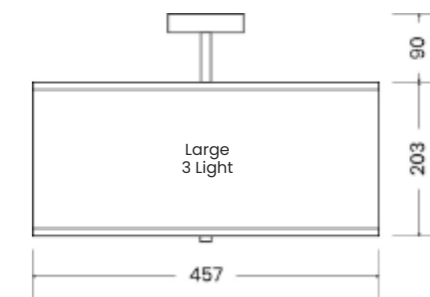
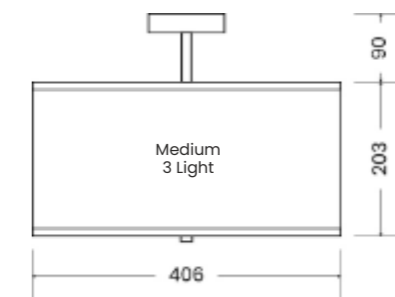
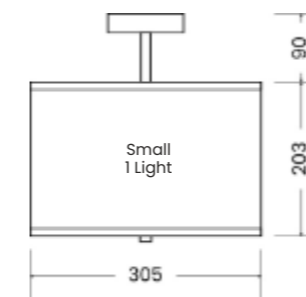

### Custom options:

The Contessa Bronte pendants are custom made to order. Lead times range from 2-4 weeks. If required, custom options include changing the shade dimensions, shade finish, metal-ware finish and rod length to your specifications. Contact our friendly sales support staff for more assistance if required.

\*Pictured

# Valoré



CONTESSA  
bespoke lighting design

# Valoré

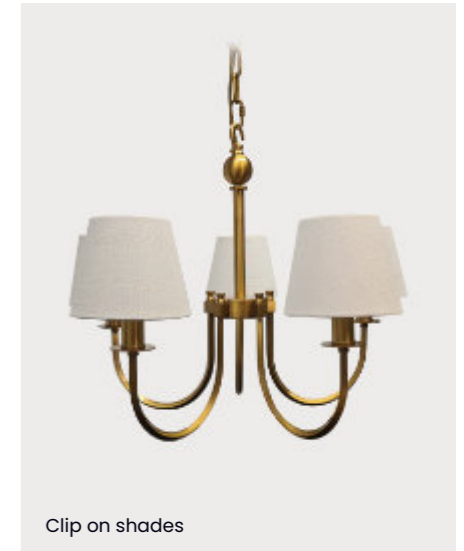
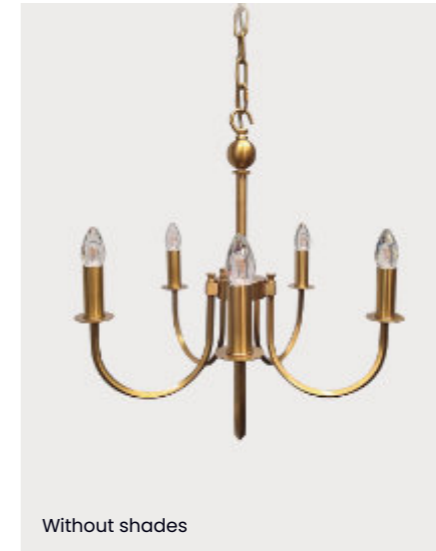
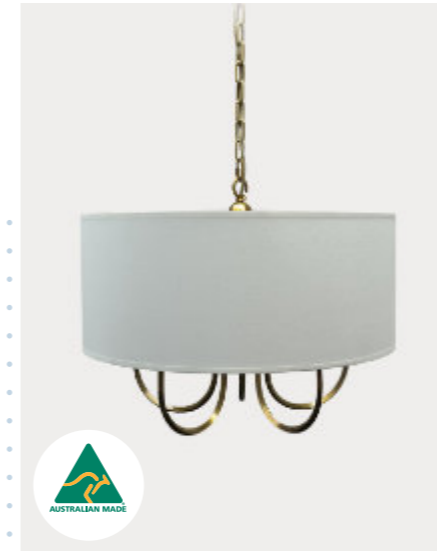

### Physical Characteristics:

Dimensions:  
545mm DIA x 450mm H (+ suspension)

#### Mounting:

- Chain suspension 1.2m chain, canopy 120x25mm
- Rod suspension <1.2m fixed rod, canopy 120x25mm

Available with or without the shade. Select the shade finish from the Contessa designer fabric sample folder.

SOLD WITH OR WITHOUT SHADE

### Electrical Configuration:

Power:  
5 x E14 lampholders

Control gear:  
240V E14

Dimming options:  
Use dimmable globes

### Finishes:



Brass



Polished Nickel  
(MOQ 5+ units. Not a stock item)



Dark Bronze  
(MOQ 5+ units. Not a stock item)

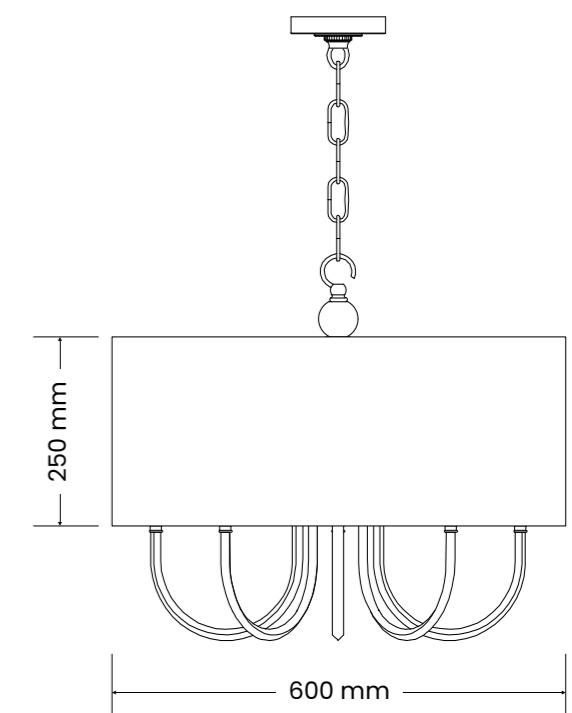
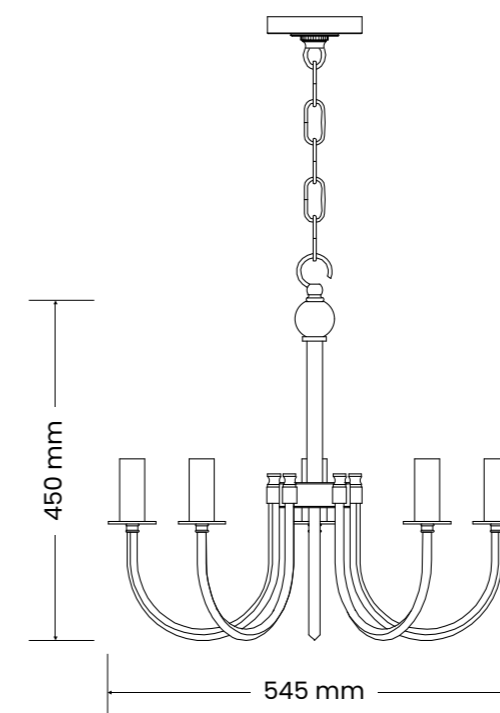

# Romá



**CONTESSA**  
bespoke lighting design

# Romá

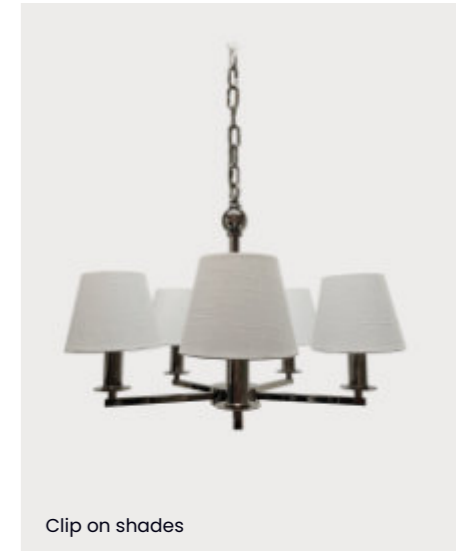
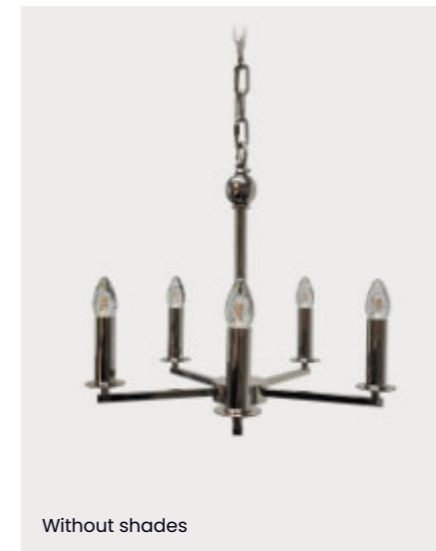
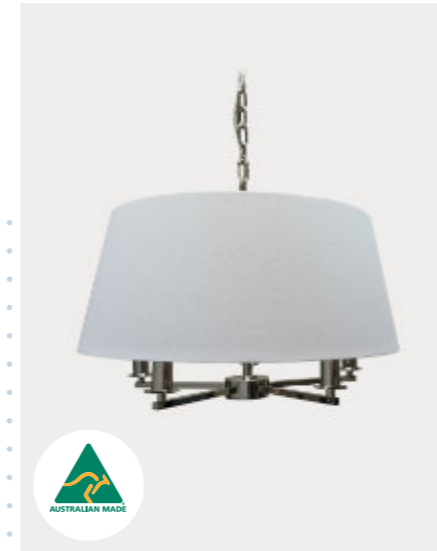

Without shades

Clip on shades

### Physical Characteristics:

**Dimensions:**  
500mm DIA x 378mm H (+ suspension)

#### Mounting:

- Chain suspension 1.2m chain, canopy 120x25mm
- Rod suspension <1.2m fixed rod, canopy 120x25mm

Available with or without the shade. Select the shade finish from the Contessa designer fabric sample folder.

SOLD WITH OR WITHOUT SHADE

### Electrical Configuration:

**Power:**  
5 x E14 lampholders

**Control gear:**  
240V E14

**Dimming options:**  
Use dimmable globes

### Finishes:



Brass



Polished Nickel



Dark Bronze  
(MOQ 5+ units. Not a stock item)

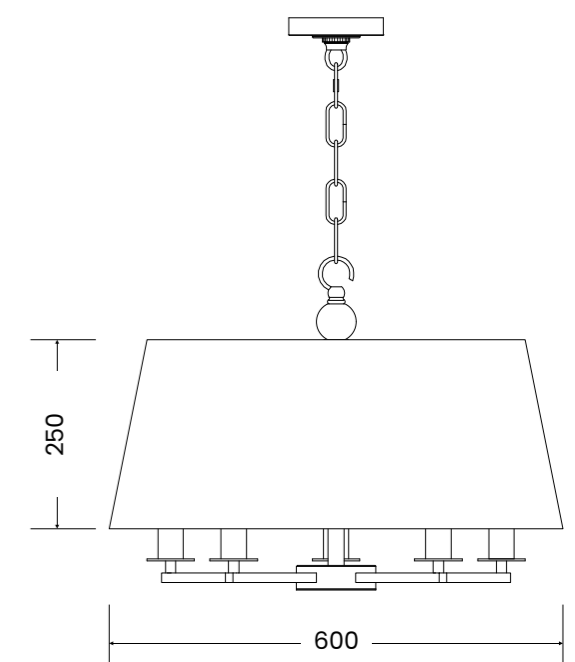
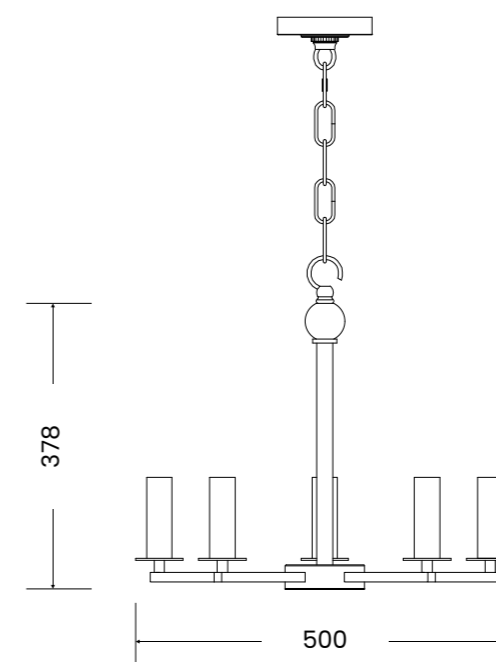

# CONT=SSA

Tel: 1300 887 948

Email: [sales@contessalighting.com.au](mailto:sales@contessalighting.com.au)

Web: [www.contessalighting.com.au](http://www.contessalighting.com.au)