

# Vertii





**TRIDONIC**  
FLEX LIGHT ENGINES

**DALI**  
OPTIONAL

**IP20**  
RATED





**INDIRECT**  
LIGHT

**PHYSICAL CHARACTERISTICS:**

**DIAMETERS**

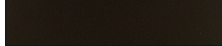
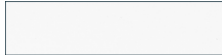
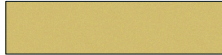
- 600mm
- 900mm
- 1200mm

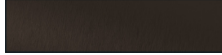
**FRAME FINISHES:** *(Powder coated - all diameters)*

- Texture Black 
- Texture White 
- Gold Pearl 
- Copper Bronze 
- Dark Bronze 
- Texture Silver 
- Custom Powder Coat Finish: *Please specify,*

**PROFILE SIZE**

12mm W x 30mm H - Aluminium

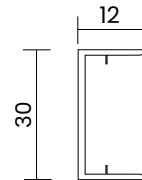

**ELECTRICAL CONFIGURATION:**

**TRIDONIC LIGHT ENGINE** *(Constant Voltage)*

600mm = 20 Watts | 2500 Lumens  
900mm = 31 Watts | 3900 Lumens  
1200mm = 41 Watts | 5200 Lumens

**DISTRIBUTION**

In-Direct light. 100° Diffused.

**CCT**

- 3000K Warm White
- 4000K Cool White
- 5000K Day Light
- RGB *(Different wattage applies)*
- RGBW *(Different wattage applies)*

**CRI**

- CRI >80 (standard)

**IP RATING**

IP20 (For indoor use only. Should not be used in wet areas)

**DIMMING**

- Phase Cut *(Included)*
- SwitchDIM
- DALI

**CONTROL GEAR**

Contessa constant voltage P/C dimmable driver  
Tridonic One4All DALI constant voltage driver

**WARRANTY**

- 3 Years (standard)
- 5 Years (optional - fees apply)

**SIZE DIAGRAMS:**

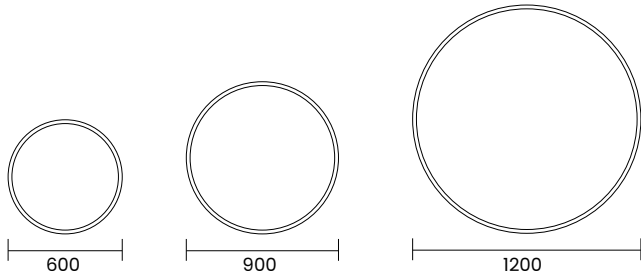

**MOUNTING OPTIONS:**

Option 1 - Suspended with Centre Canopy  
*(Driver built into canopy)*

Option 2 - Suspended with Round Canopies  
*(Remotely stored driver)*

Option 3 - Single Rod Suspension  
*(Driver built into Canopy)*

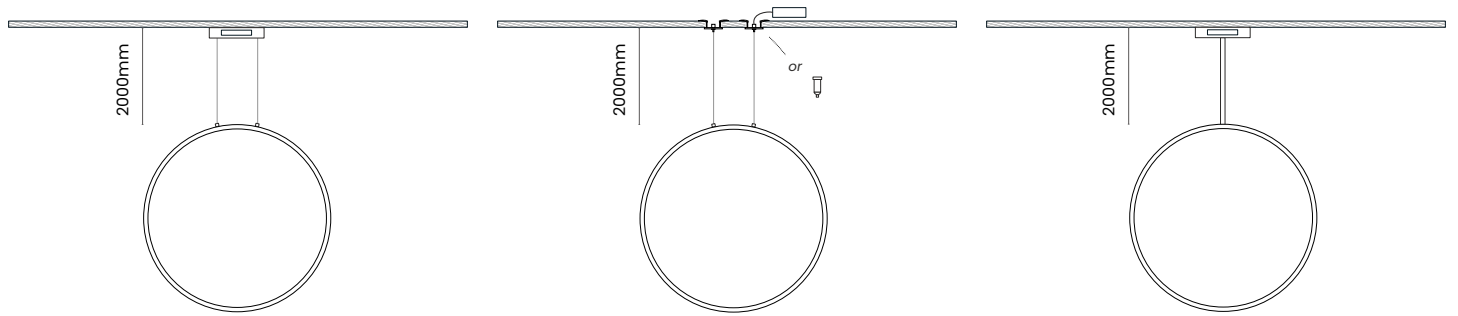

**CANOPY OPTIONS:** *(For option 2)*

38mm Mini-Mount  
*Recessed Cut-out 32mm*

70mm Recessed  
*Cut-out 51mm*

70mm Surface

100mm Surface

**CANOPY FINISHES**

All Canopies are available in all powder coat finishes.

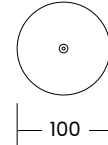
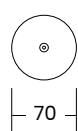
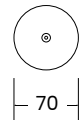
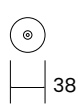
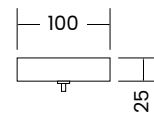
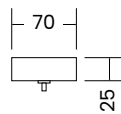
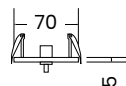

**Centre Mount Canopy Detail** *(For option 1)*

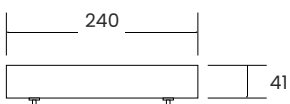
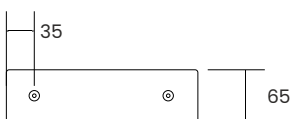

**SUSPENSION LENGTH**

Suspension lengths can be specified longer however the standard is;

Wires = 2000mm long (adjustable)

Custom length *Please specify,*



**FIXTURE WEIGHTS:**

600mm = 2 Kg

900mm = 3 Kg

1200mm = 5 Kg

**Code Generator:**

Product	Diameter	Finish	CCT	Mounting	Canopy <small>Applicable if mount option 2 is selected</small>	Driver
VERTII	600MM - 60 900MM - 90 1200MM - 120	Texture Black - BL Texture White - WH Gold Pearl - GP Copper Bronze - CB Dark Bronze - DB Texture Silver - TS CUSTOM - C/F	3000K - 3K 4000K - 4K 6500K - 5K RGB - RGB RGBW - RGBW	Option 1 - M1 Option 2 - M2 Option 3 - M3	Recess 38mm - R38 Recess 70mm - R70 Surface 70mm - S70 Surface 100mm - S100	Phase Cut - PC DALI - DA SwitchDIM - SwD
VT						

When specifying custom details e.g. finish, please include the details in the comments section of the online project quote request function on our website or include in the lighting schedule.